

**PATIO SCREEN DOOR**

**MADE TO ORDER**

**SHIPPED ANYWHERE IN CANADA!!!\***

*\*KD (knock down) in a protective tube*



PARTS ON THIS PAGE USED TO MAKE OUR EXTRUDED DOORS  
GO TO PAGE A-1 FOR MORE DETAILS

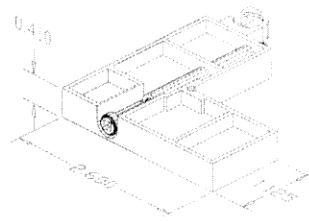

**90020**  
METAL OPEN-END (FEMALE)

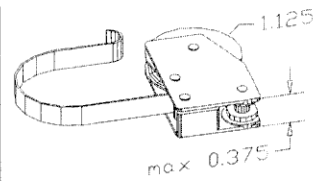

**90021** WHEEL PLASTIC  
**90021A** WHEEL METAL  
CLOSED-END (MALE)

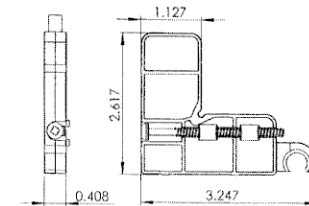

**90020B-T**  
METAL OPEN END

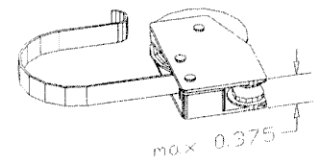

**90021B**  
METAL OPEN-END (FEMALE)

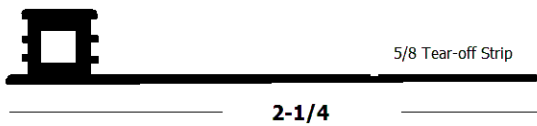

**56062** 84" BLACK  
**56062-W** 84" WHITE

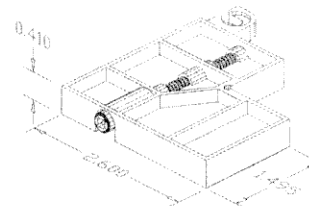

**90020A**  
METAL OPEN-END (FEMALE)  
WIDER (LEAST POPULAR)



CORNER	WORKS WITH WHEELS:
90020	90021, 90021A, 90021B
90020B-T	90021B
90020A	90021, 90021A, 90021B

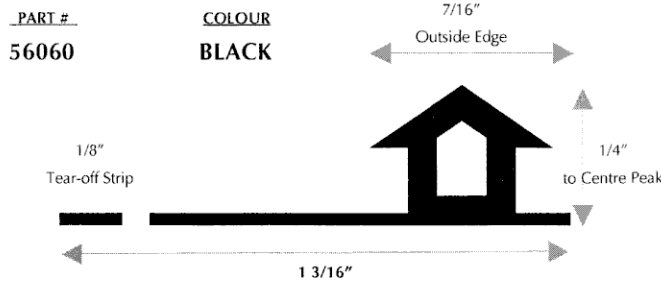

PART #  
**56060** COLOUR  
**BLACK**

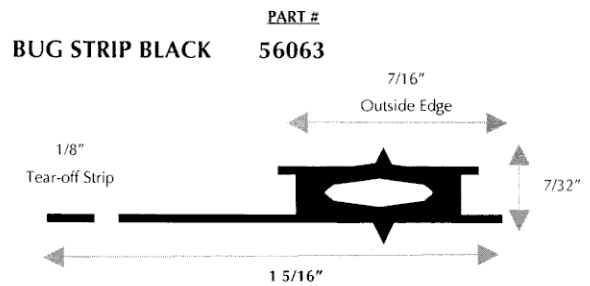

PART #  
**BUG STRIP BLACK 56063**

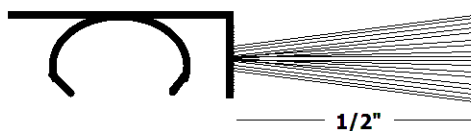

**SCHLEGEL** 84" BLACK  
**SCHLEGELW** 84" WHITE  
**SCHLEGEL-120** 120" BLACK

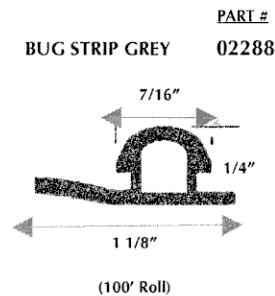

PART #  
**BUG STRIP GREY 02288**

*Super-fast shipping!* t. 1-877-744-2634 f. 1-877-744-1877 [sales@tiipinc.com](mailto:sales@tiipinc.com)

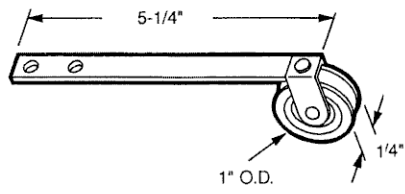

B-527 Nylon Wheel  
B-528 Steel Wheel

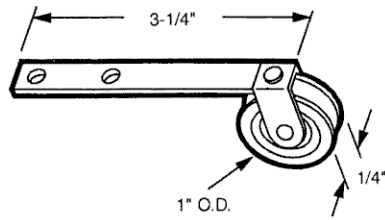

B-523 Nylon Wheel  
B-524 Steel Wheel

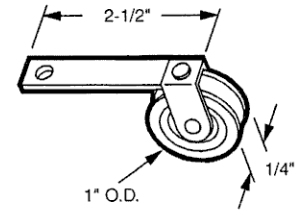

02506-1 Nylon Wheel  
02506-5 Metal Wheel

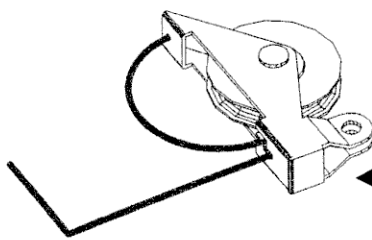

02509-P 1 1/8" Nylon Wheel  
02509-S 1 1/8" Steel Wheel

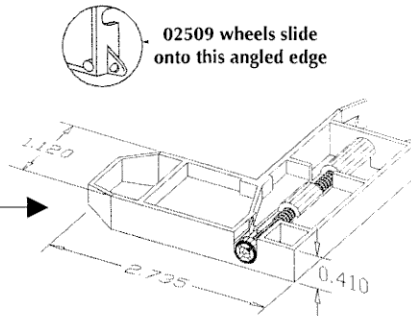

02538

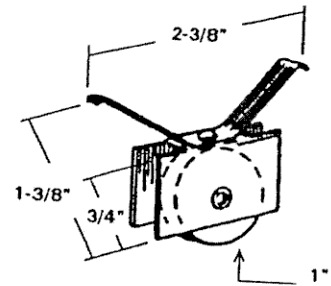

02512

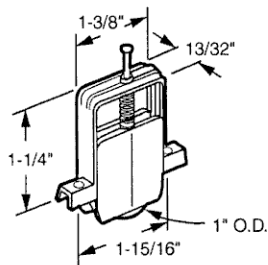

02515

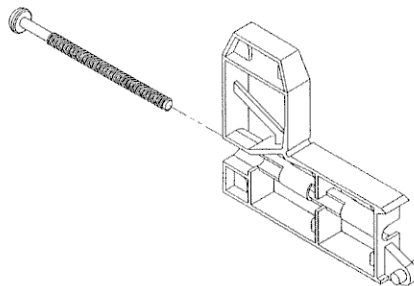

07125 (DOUBLE MALE END)

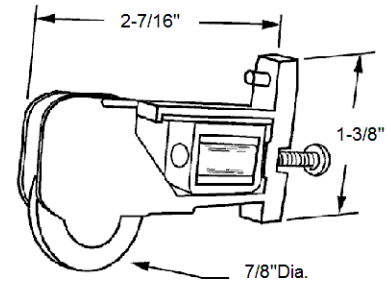

3-271T

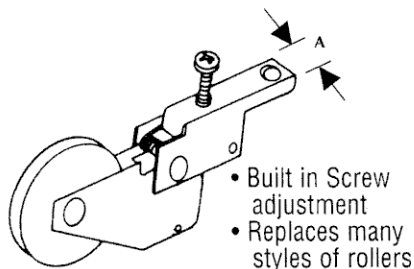

02518 A = 7/16"  
02519 A = 5/16"

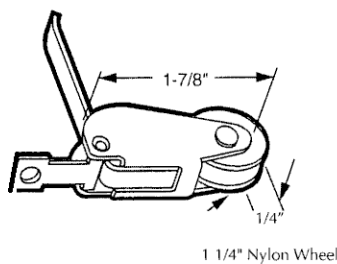

02503

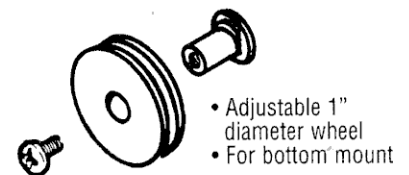

02521

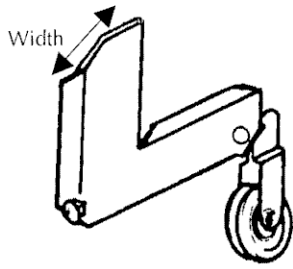

- 02524 1" Width + 15/16" Nylon Wheel
- 02524-A 1 1/8" Width + 15/16" Nylon Wheel
- 02524-B 1 3/16" Width + 15/16" Nylon Wheel
- 02524-S 1 1/8" Width + 1" Steel Wheel

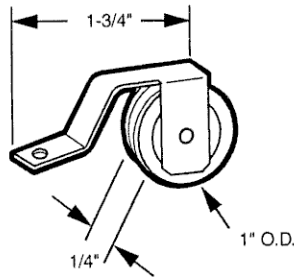

- 02526-P Nylon Wheel
- 02526-S Steel Wheel

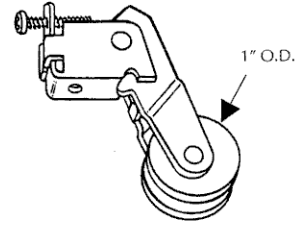

02528-A

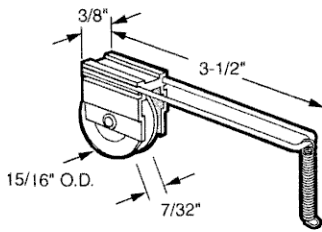

B-519

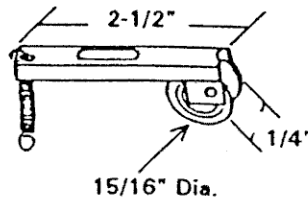

90000

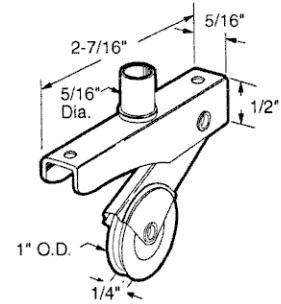

- 750 Nylon Wheel
- 750-S Steel Wheel

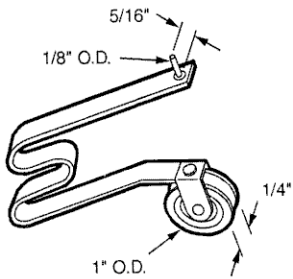

B-644

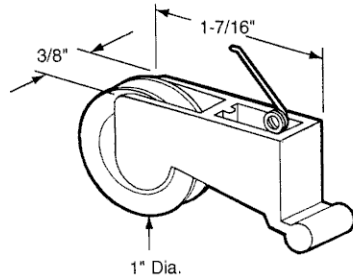

90035

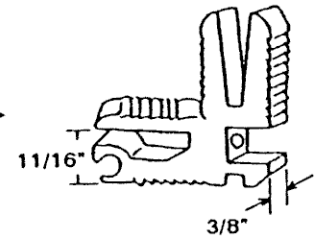

93001

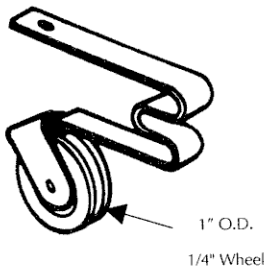

- 02500 Nylon Wheel
- 00101S Metal Wheel

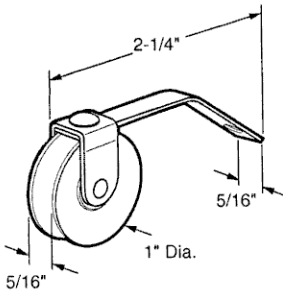

B-576

**Nylon Wheels**

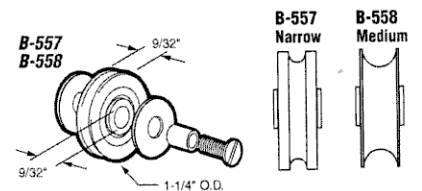

*Super-fast shipping!*

t. 1-877-744-2634

f. 1-877-744-1877

[sales@tiipinc.com](mailto:sales@tiipinc.com)

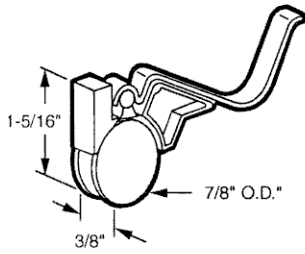

**B-511**

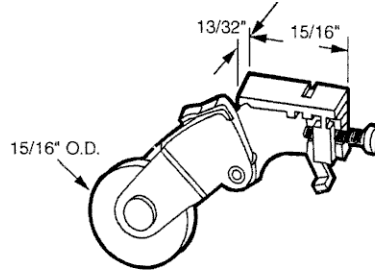

**B-647**

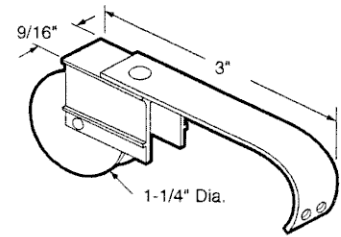

**B-659**

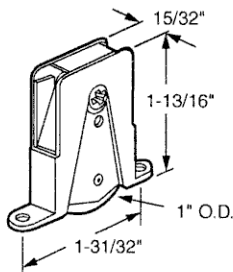

**B-684**

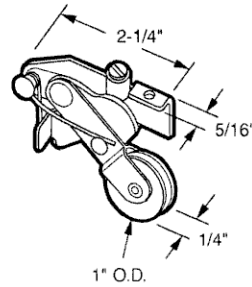

**90036 Nylon Wheel**  
**90036S Steel Wheel**

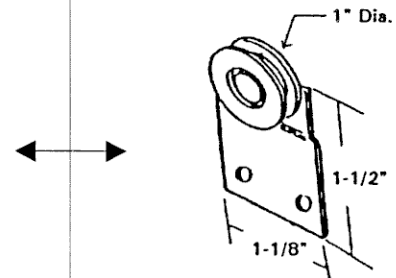

**90037**

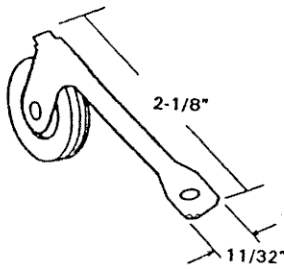

**D-750-N NYLON WHEEL**  
**D-750-S-1 STEEL WHEEL**

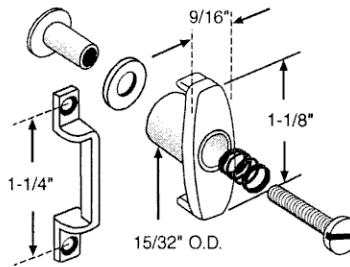

**A-164**

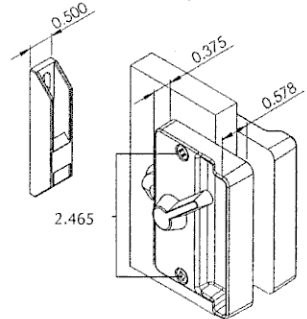

**02564 WHITE**  
**02564 B BLACK**

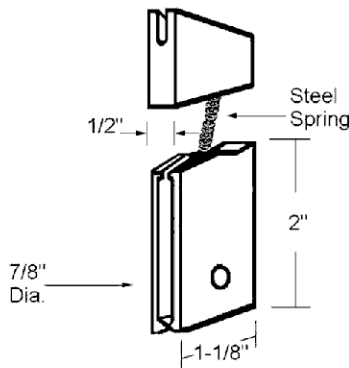

**3-277T**

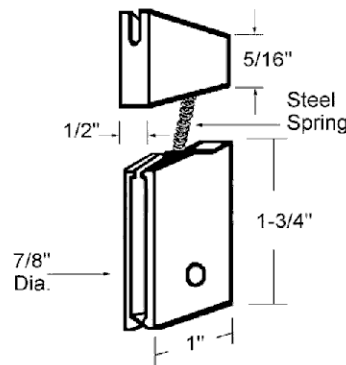

**3-279T**

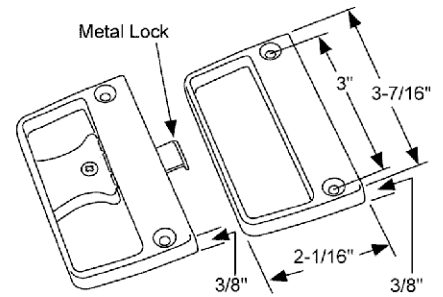

**3-3229T White**

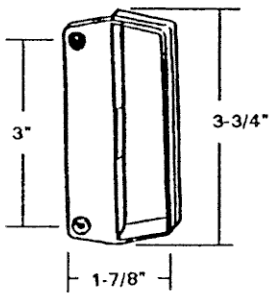

02566

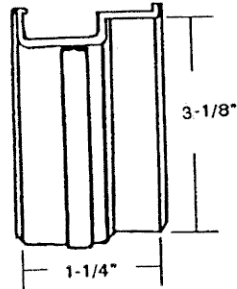

09050A

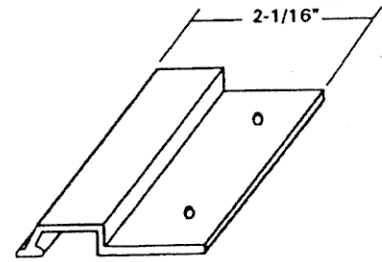

09040  
Lengths 3 7/8" - 4 1/4"

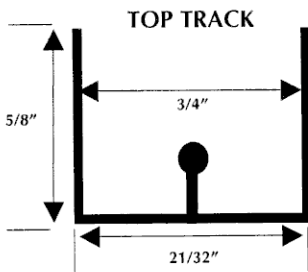

PSDT-TOP  
6' or 12' White

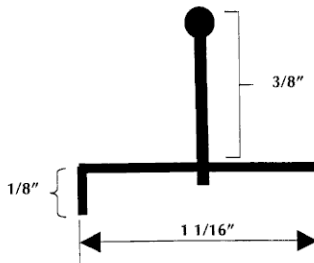

PSDT-BOTTOM  
Clear Anodized Aluminum 6' or 12'

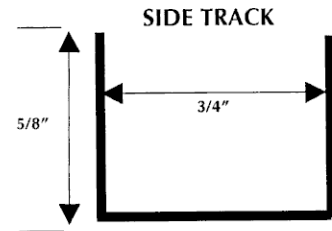

PSDT-SIDE  
7' White

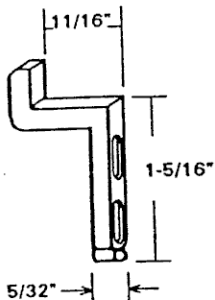

261

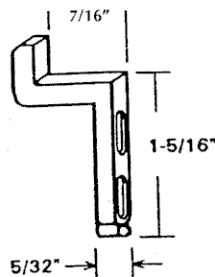

262

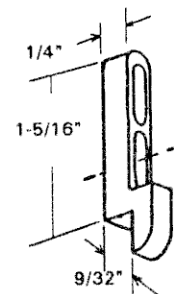

02558

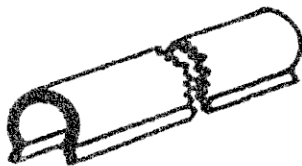

93003-6 6' Stainless Steel  
93003 7' Stainless Steel  
93003-8 8' Stainless Steel

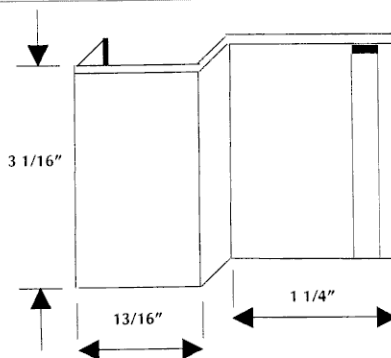

09050

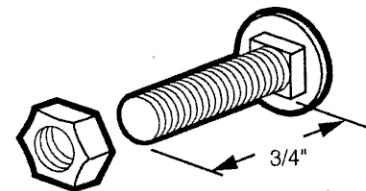

B-561

Super-fast shipping! t. 1-877-744-2634 f. 1-877-744-1877 [sales@tiipinc.com](mailto:sales@tiipinc.com)

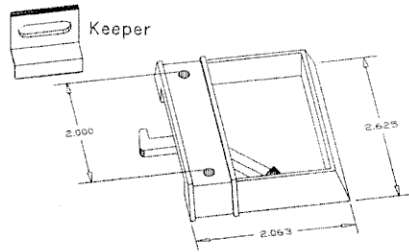

K-3077 Mill Finish  
K-3077B Brown  
K-3077W White

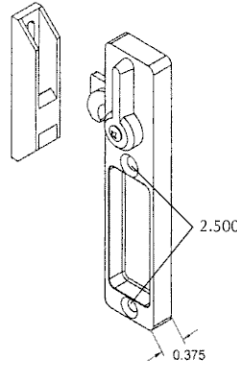

07103 WHT WHITE

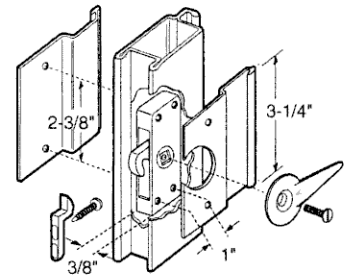

A-152

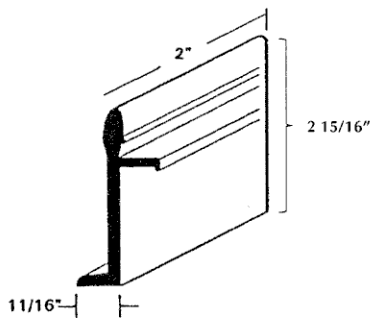

90092C

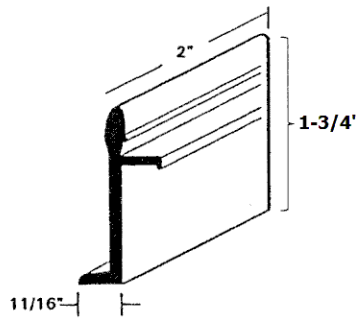

90092

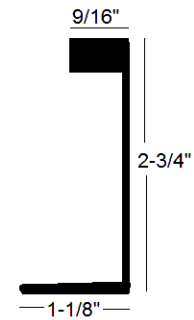

793.06 White

**GRILLS DISCONTINUED - LIMITED STOCK REMAINING**

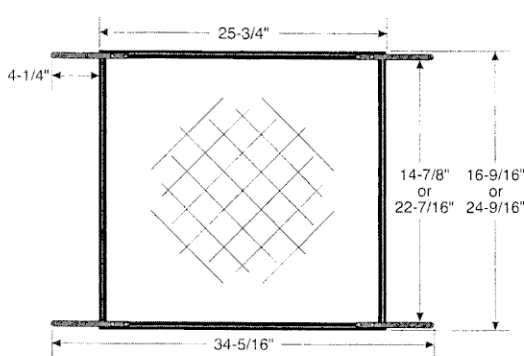

**For Storm Doors**

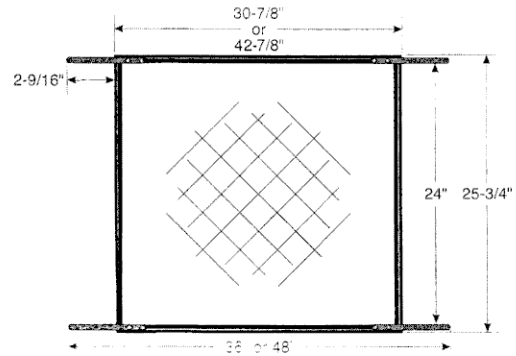

**For Screen Doors**

**16"**

Part Number	Colour
00900	Mill
00901	Satin
00902	Black
00903	White
00904	Brown

**24"**

Part Number	Colour
00910	Mill
00911	Satin
00912	Black
00913	White
00914	Brown

**36"**

Part Number	Colour
00950	Mill
00951	Satin
00952	White
00953	Brown

**48"**

Part Number	Colour
00956	Mill
00957	Satin
00958	White
00959	Brown

We're your warehouse! t. 1-877-744-2634 f. 1-877-744-1877 [sales@tipinc.com](mailto:sales@tipinc.com)

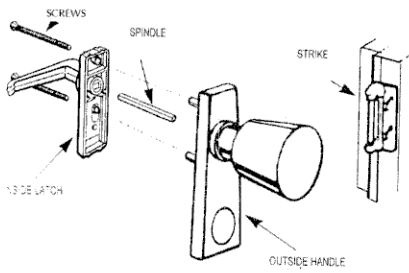

**SK-15 Aluminum**

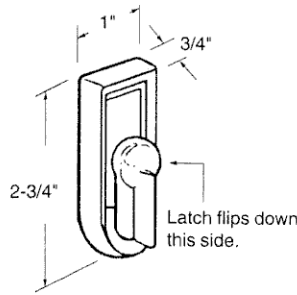

**DL-550-AM White**

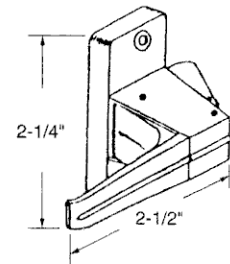

**SD-AM White**  
**SD-3215 Brown**

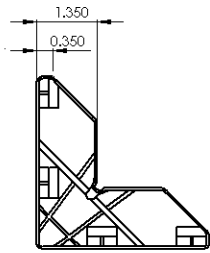

**CD-H1AR Storm Door Corner**

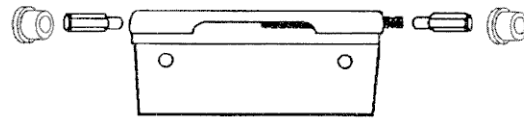

**STORM DOOR HINGE**

Complete with 1 spring, 2 pins & 2 bushings

- |           |                 |
|-----------|-----------------|
| 90039     | WHITE           |
| 90039-BLK | BLACK           |
| 90039-BN  | COMMERCIAL BRN. |
| 90039-BR  | CHOCOLATE BROWN |
| 90039-GLD | GOLD            |
| 90039-IV  | IVORY           |
| 90039-ML  | MILL FINISH     |



**Z BAR**

- 90050 - White
- 90050-Mill
- 90050-Brown
- 90050-Ivory

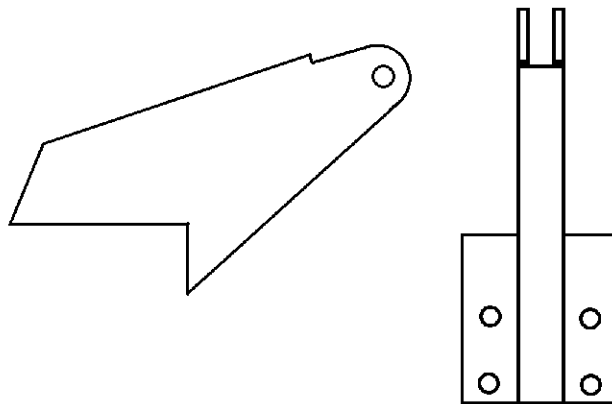

**Storm Door Enclosure Bracket**

- |          |                 |
|----------|-----------------|
| B2700    | WHITE           |
| B2700-CB | CHOCOLATE BROWN |
| B2700-IV | IVORY           |

*Super-fast shipping!*    t. 1-877-744-2634    f. 1-877-744-1877    [sales@tiipinc.com](mailto:sales@tiipinc.com)